

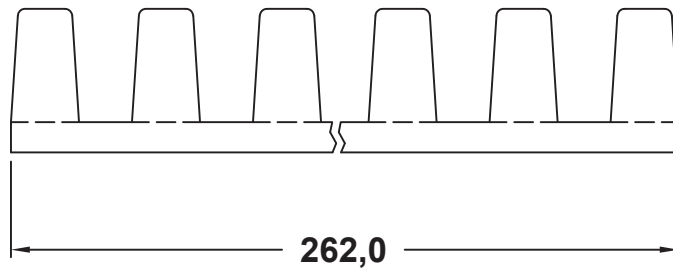

DIM.	TOL.
5mm DOWN	±0.2
5~20mm	±0.3
20~40mm	±0.4
40~60mm	±0.5
60~100mm	±0.8
100mm UP	±1.0

REVISIONS			
REV	DESCRIPTION	DATE	BY

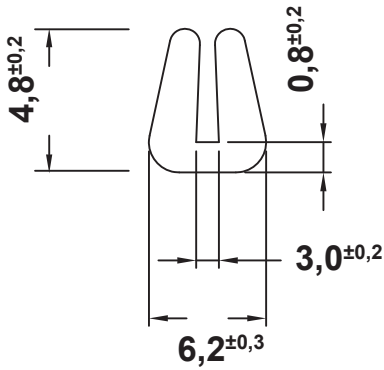

THICKNESS 2,5-3,0

		TITLE MOVEABLE BUSHING	
		MATERIAL PA 6.6 V2(UL94)	DATE 15/04/2024
PART NUMBER 6787AA00		DRAWING NUMBER 24/04/15.678X.E	
DRAWN A.C.		COLOR NATURAL	CHECK
SIZE A4	SCALE 5:1	UNIT mm.	REV A
UNLESS OTHERWISE SPECIFIED TOLERANCE SEE ABOVE			APPROVED