

DIM.	TOL.
5mm DOWN	±0.2
5~20mm	±0.3
20~40mm	±0.4
40~60mm	±0.5
60~100mm	±0.8
100mm UP	±1.0

REVISIONS			
REV	DESCRIPTION	DATE	BY

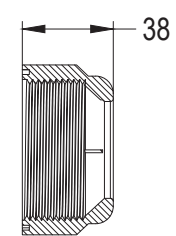
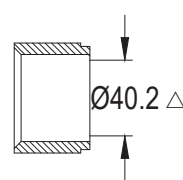
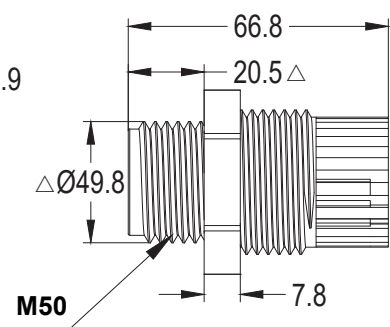
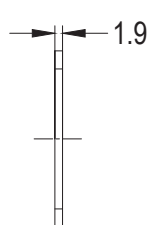
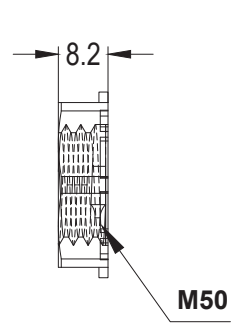
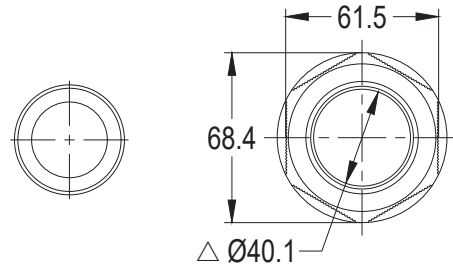
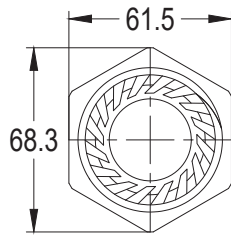
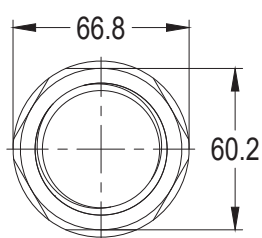

Locknut
A

Washer
B

Body
C Claw
D

Seal
E

SealingNut
F

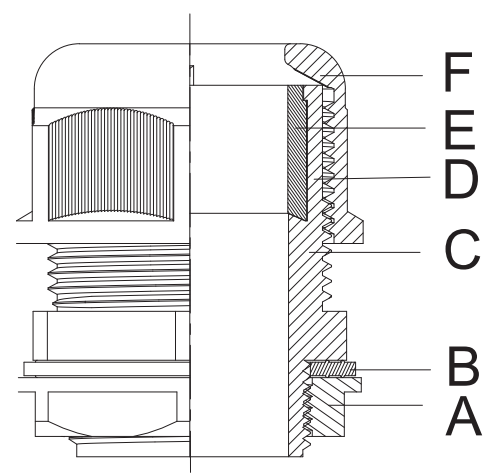

P/N RAL 9005	P/N RAL 7035	P/N RAL 7001
19285AA019005	19285AA117035	19285AA117001

Flammability: UL94-V2
Temperature: -40°C ... +105°C
IP Rating: IP 68



		TITLE CABLE GLAND	
		MATERIAL PA 6.6	DATE 15/05/2024
PART NUMBER SEE ABOVE		DRAWN E.B.	
DRAWING NUMBER 24/05/15.19285.E		CHECK	
SIZE A4	SCALE NTS	COLOR SEE ABOVE	APPROVED
UNIT mm.	REV A	UNLESS OTHERWISE SPECIFIED TOLERANCE SEE ABOVE	