

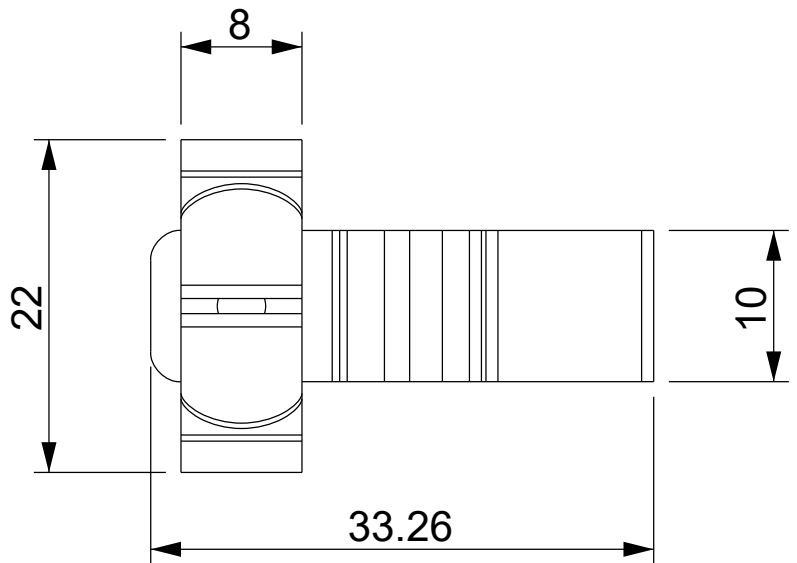

REVISIONS			
REV	DESCRIPTION	DATE	BY

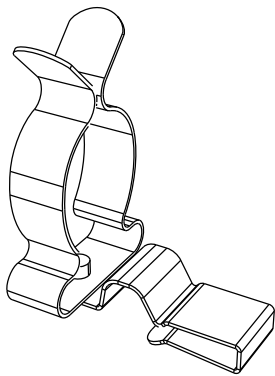
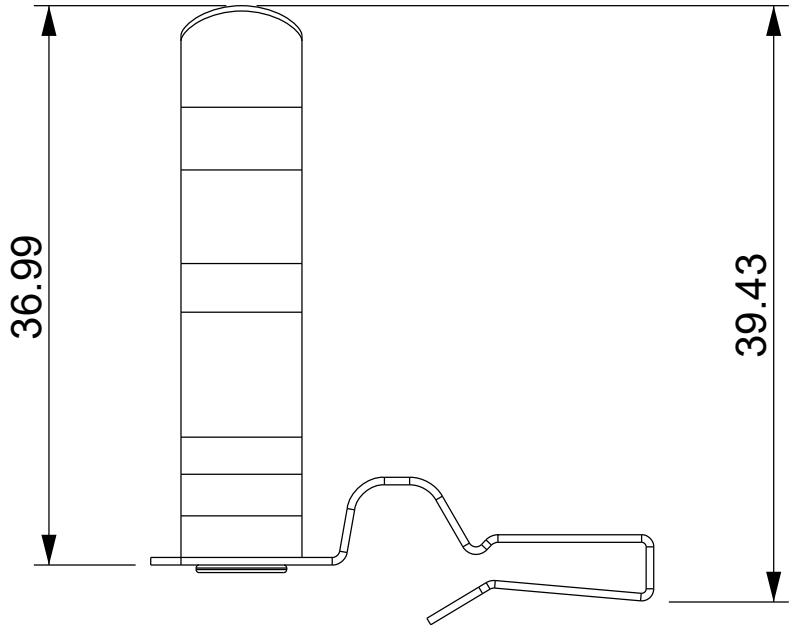
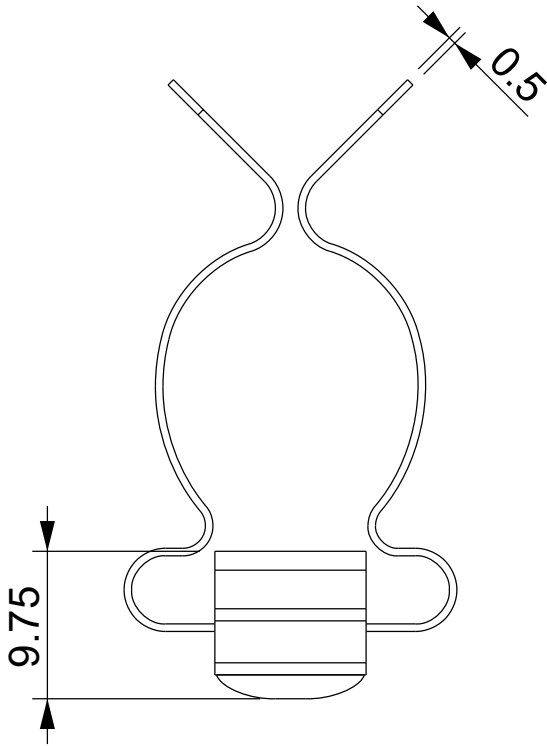

		TITLE <b>SHIELD CLAMP</b>	
		MATERIAL STEEL ZINC PLATED	DATE 28/03/2024
PART NUMBER 19181MC94		DRAWING NUMBER 24/03/28.19181.E	
COLOR GREY		CHECK E.B.	
SIZE A4	SCALE 1:2	UNIT mm.	REV A
UNLESS OTHERWISE SPECIFIED TOLERANCE SEE ABOVE		APPROVED	