

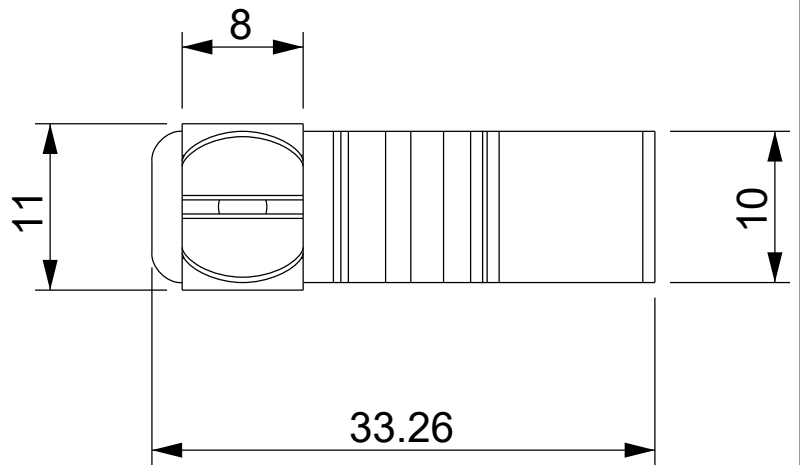

REVISIONS			
REV	DESCRIPTION	DATE	BY

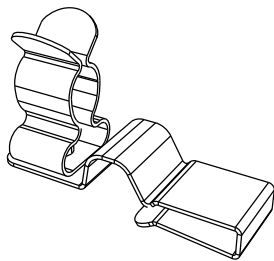
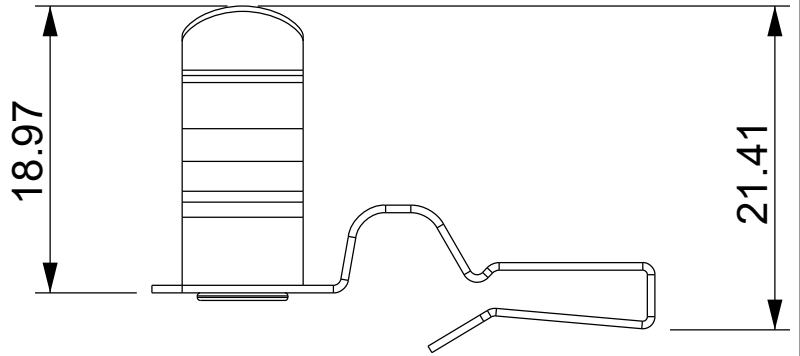
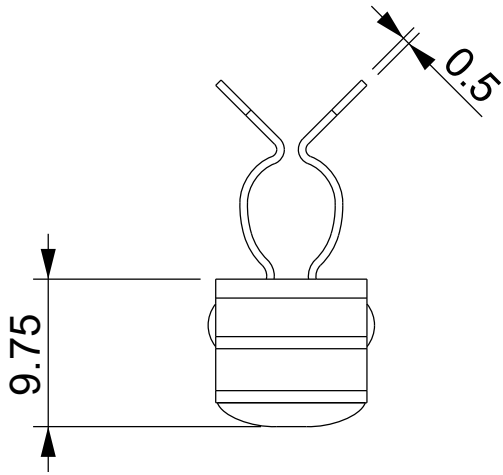

		TITLE SHIELD CLAMP	
		MATERIAL STEEL ZINC PLATED	DATE 28/03/2024
PART NUMBER 19178MC94		DRAWING NUMBER 24/03/28.19178.E	
DRAWN E.B.		COLOR GREY	CHECK
SIZE A4	SCALE 1:2	UNIT mm.	REV A
UNLESS OTHERWISE SPECIFIED TOLERANCE SEE ABOVE		APPROVED	