

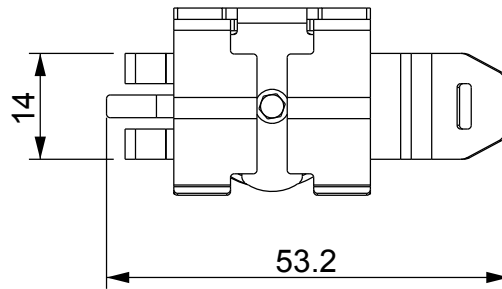

REVISIONS			
REV	DESCRIPTION	DATE	BY

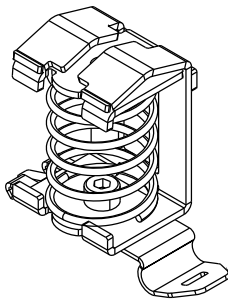
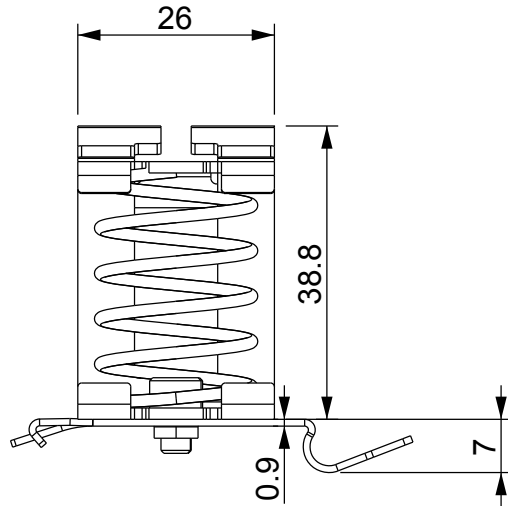
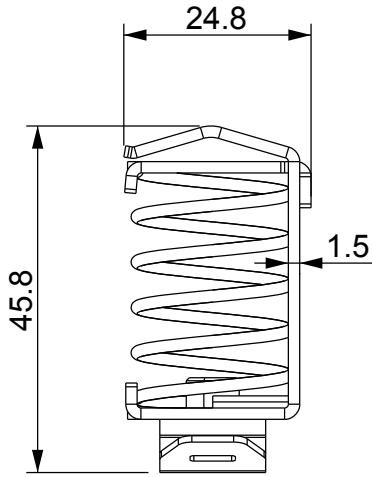

		TITLE SPRING STEEL	
		MATERIAL STEEL ZINC PLATED	DATE 19/03/2024
PART NUMBER 19147MC94		DRAWING NUMBER 24/03/19.19147.E	
DRAWN A.C.		CHECK	
SIZE A4	SCALE 1:1	UNIT mm.	REV A
UNLESS OTHERWISE SPECIFIED TOLERANCE SEE ABOVE		APPROVED	