

REVISIONS			
REV	DESCRIPTION	DATE	BY

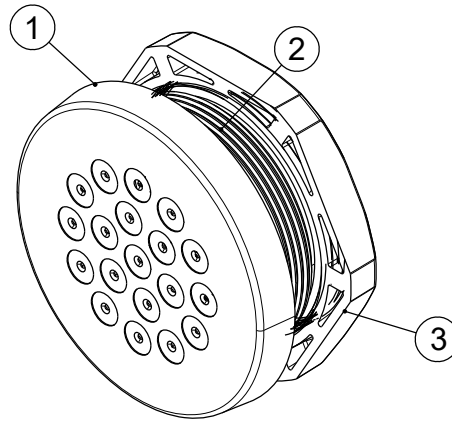
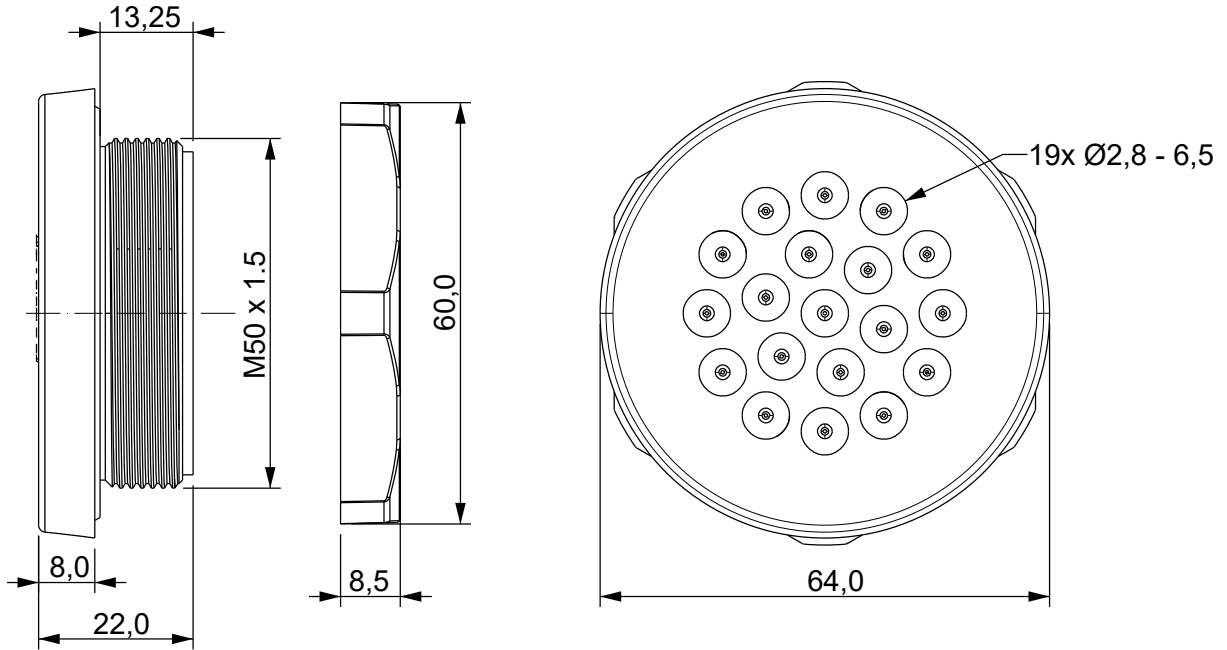

P/N GREY	P/N BLACK
19103PS11	19107PS01

Id	Description	Material	Q.ty
1	Body	TPE	1
2	Thread	PA	1
3	Locknut	PA	1

**Flammability:** UL94-V0, self-extinguishing  
**Temperature:** -40°C ... +105°C  
**Properties:** halogen-free, silicone-free

Recommended cut-out:  
 Ø50.5 mm

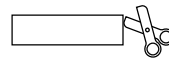

UL TYPE 12, 4X	APPROVED MARINE TYPE	UL US
NEMA 12, 4X	HL3 EN 45545-2	IP66 IP68
ECOLAB	UL94-V0	UV ISO 4892-2A
		RoHS COMPLIANT

		TITLE <b>CABLE GLAND</b>	
		MATERIAL SEE ABOVE	DATE 27/03/2024
PART NUMBER SEE TABLE		DRAWN E.B.	
DRAWING NUMBER 24/03/27.1910X.E		CHECK	
SIZE A4	SCALE 1:2	COLOR SEE TABLE	APPROVED
UNIT mm.	REV A	UNLESS OTHERWISE SPECIFIED TOLERANCE SEE ABOVE	