

REVISIONS			
REV	DESCRIPTION	DATE	BY

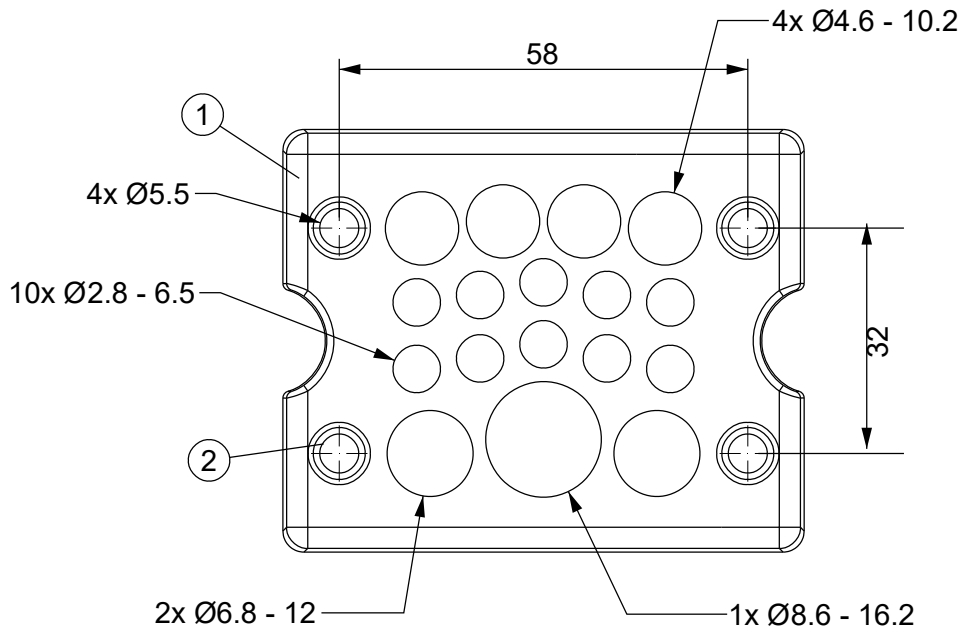

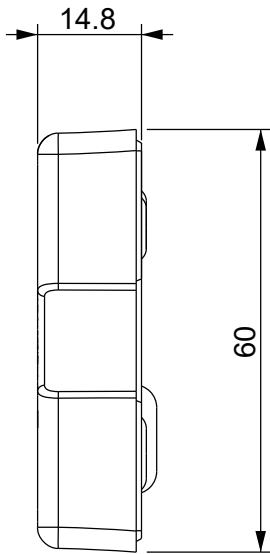

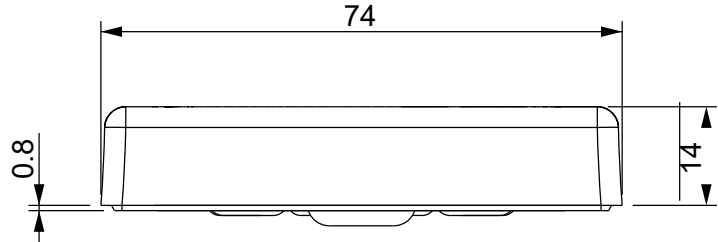

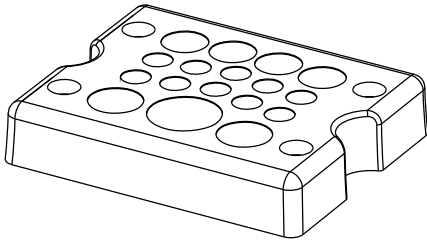

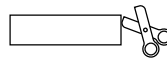
Id	Description	Material	Q.ty	P/N GREY	P/N BLACK
1	Body	TPE	1		
2	Internal frame	PA	1	19075PS11	19078PS01

Flammability: UL94-V0, self-extinguishing
Temperature: -40°C ... +105°C
Properties: halogen-free, silicone-free

Recommended cut-out:
46 x 46 mm



APPROVED  MARINE TYPE			
NEMA 12	NEMA 4X	IP66	
ECOLAB			RoHS COMPLIANT

		TITLE CABLE GLAND PLATES	
		MATERIAL SEE ABOVE	DATE 26/03/2024
PART NUMBER SEE TABLE		DRAWN E.B.	
DRAWING NUMBER 24/03/26.1907X.E		CHECK	
SIZE A4	SCALE 1:2	UNIT mm.	REV A
UNLESS OTHERWISE SPECIFIED TOLERANCE SEE ABOVE		APPROVED	