

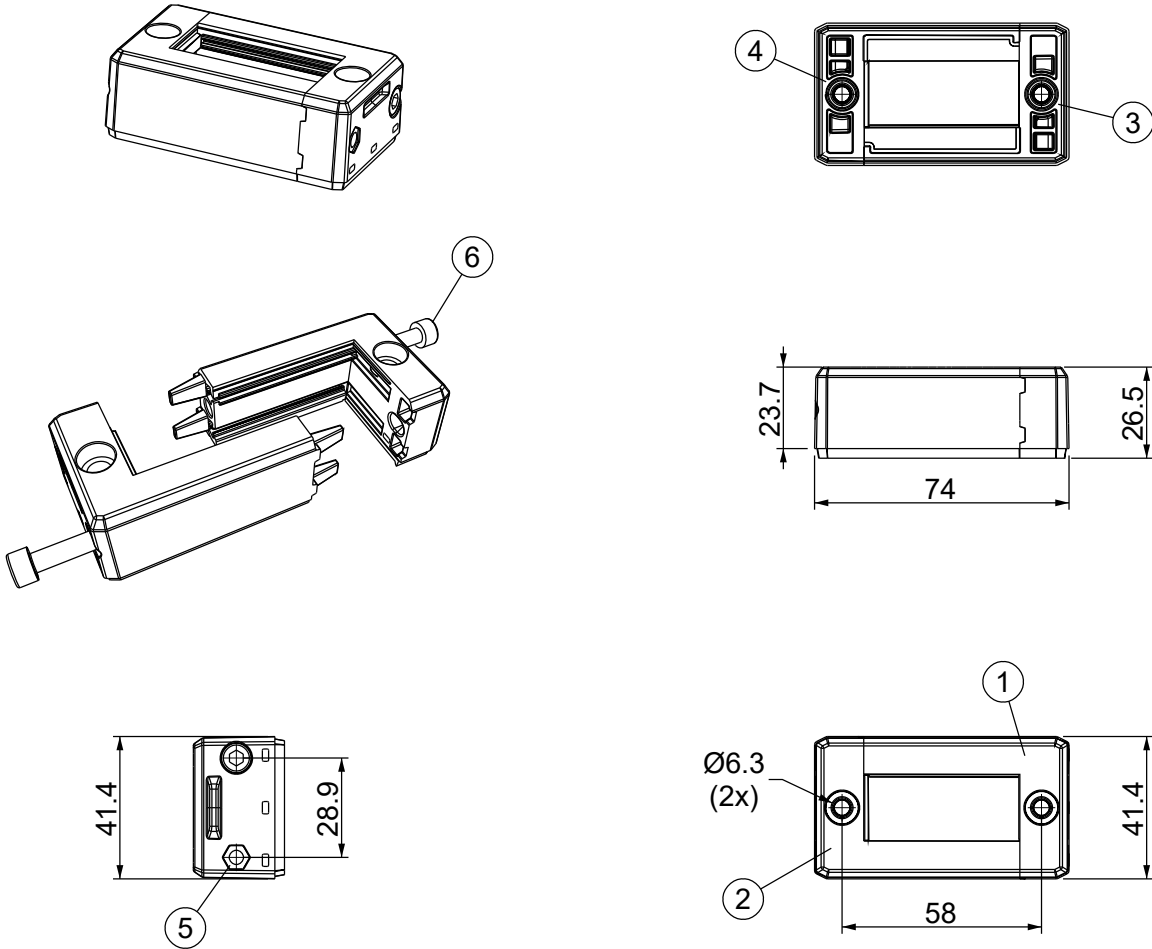











REVISIONS			
REV	DESCRIPTION	DATE	BY



Id	Description	Material	Q.ty
1	Top	PP + GF	1
2	Bottom	PP + GF	1
3	Gasket Top	TPE	1
4	Gasket Bottom	TPE	1
5	Nut	SS304	2
6	Screw Hex M5x0.8 L=68	SS304	2

Flammability: UL94-V0, self-extinguishing
Temperature: -40°C ... +155°C
Properties: halogen-free, silicone-free

Recommended cut-out: 40 x 18 mm 					
					

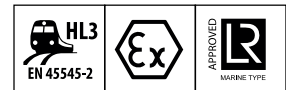

		TITLE DIVISIBLE CABLE ENTRY SYSTEM			
		MATERIAL SEE ABOVE		DATE 22/03/2024	
PART NUMBER 18987FG01		DRAWING NUMBER 24/03/22.18987.E		DRAWN E.B.	
SIZE A4		SCALE 1:2		CHECK	
UNIT mm.		REV A		UNLESS OTHERWISE SPECIFIED TOLERANCE SEE ABOVE	
				APPROVED	