

DIM.	TOL.
5mm DOWN	±0.2
5~20mm	±0.3
20~40mm	±0.4
40~60mm	±0.5
60~100mm	±0.8
100mm UP	±1.0

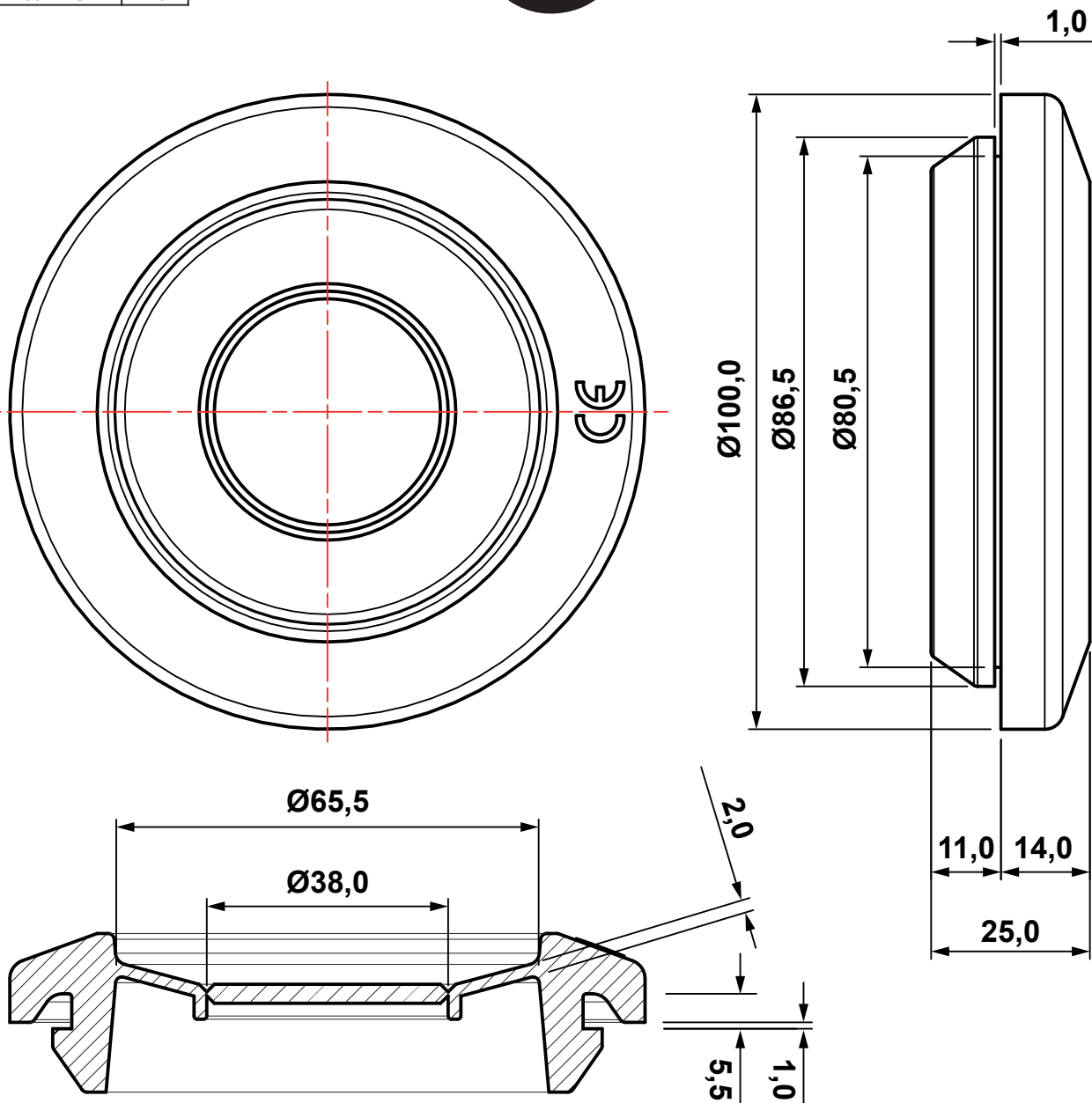

REVISIONS			
REV	DESCRIPTION	DATE	BY



MAX. PANEL THICKNESS: MIN. 1,0 ... MAX. 5,5
HOLE PANEL: 80,5
WORKING TEMPERATURE: -40°C ... + 130°C
PROTECTION IP67

P/N	color	material
22008PF019011	RAL 9011	TPE-SEBS
22008PF119010	RAL 9010	TPE-SEBS
22008PF117035	RAL 7035	TPE-SEBS
22008PV02	WHITE	TPE-SEBS V0

				TITLE GROMMET	
				MATERIAL SEE ABOVE	
PART NUMBER SEE ABOVE				DRAWN A.C.	
				DRAWING NUMBER 22.04.06.22008.0.E	
SIZE A4				COLOR SEE ABOVE	
				CHECK	
SCALE 1:1		UNIT mm.		REV A	
UNLESS OTHERWISE SPECIFIED TOLERANCE SEE ABOVE				APPROVED	