

DIM.	TOL.
5mm DOWN	±0.2
5~20mm	±0.3
20~40mm	±0.4
40~60mm	±0.5
60~100mm	±0.8
100mm UP	±1.0

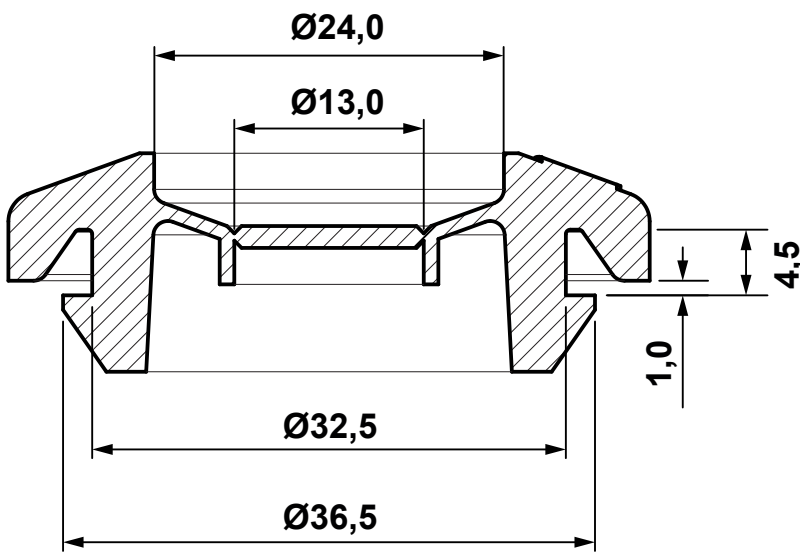

REVISIONS			
REV	DESCRIPTION	DATE	BY

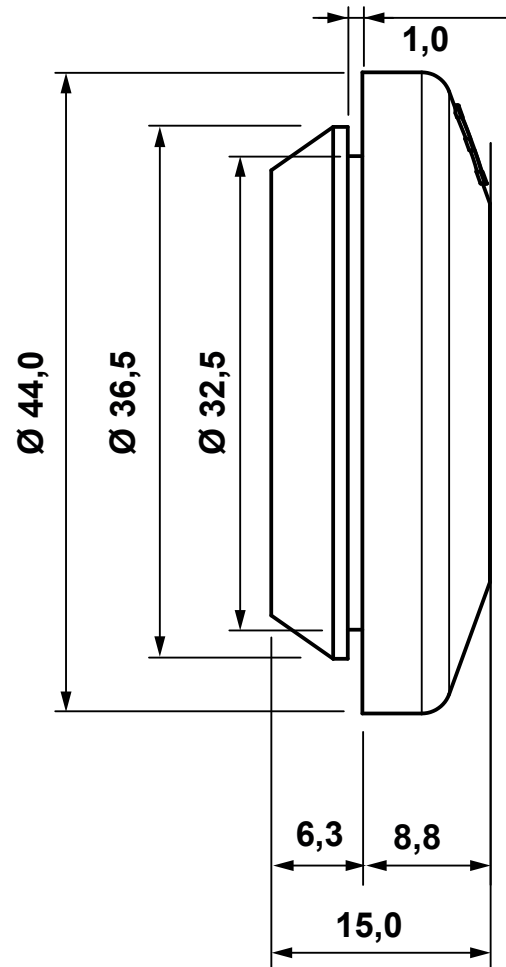
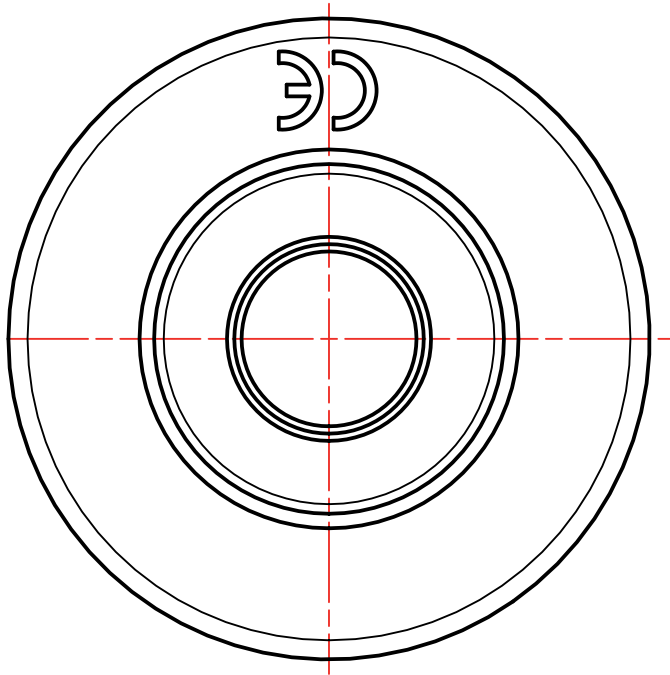

MAX. PANEL THICKNESS: MIN. 1,0 ... MAX. 4,5
HOLE PANEL: 32,5
WORKING TEMPERATURE: -40°C ... + 130°C
PROTECTION IP67

P/N	color	material
22004PF019011	RAL 9011	TPE-SEBS
22004PF119010	RAL 9010	TPE-SEBS
22004PF117035	RAL 7035	TPE-SEBS
22004PV02	WHITE	TPE-SEBS V0



TITLE GROMMET	
MATERIAL SEE ABOVE	DATE 06/04/2022
COLOR SEE ABOVE	DRAWN A.C.
PART NUMBER SEE ABOVE	CHECK
DRAWING NUMBER 22.04.06.22004.0.E	APPROVED
SIZE A4	SCALE 1:1
UNIT mm.	REV A
UNLESS OTHERWISE SPECIFIED TOLERANCE SEE ABOVE	