

DISTANZIATORI METRICI M4 CILINDRICI Ø 8,0



Descrizione tecnica

Materiale: PA 6.6

Colore: nero

Autoestinguenza: HB (UL 94)

Temperatura esercizio: -30°C ~ +150°C

Tutte le quote sono in mm.

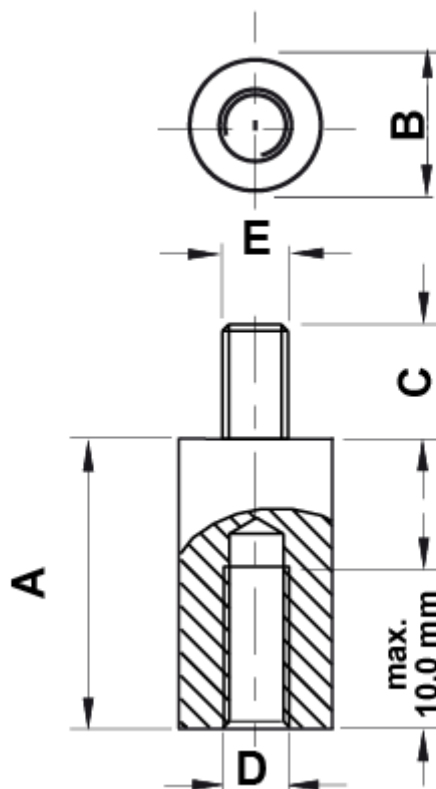

Codice	A	B	C	D	E	Conf./pezzi
10035AA0105.0	5,0	Ø 8,0	8,0	M4	M4	500

Codice	A	B	C	D	E	Conf./pezzi
10035AA0106.0	6,0	Ø 8,0	8,0	M4	M4	500
10035AA0107.0	7,0	Ø 8,0	8,0	M4	M4	500
10035AA0108.0	8,0	Ø 8,0	8,0	M4	M4	500
10035AA0109.0	9,0	Ø 8,0	8,0	M4	M4	500
10035AA0110.0	10,0	Ø 8,0	8,0	M4	M4	500
10035AA0111.0	11,0	Ø 8,0	8,0	M4	M4	500
10035AA0112.0	12,0	Ø 8,0	8,0	M4	M4	500
10035AA0113.0	13,0	Ø 8,0	8,0	M4	M4	500
10035AA0114.0	14,0	Ø 8,0	8,0	M4	M4	500
10035AA0115.0	15,0	Ø 8,0	8,0	M4	M4	500
10035AA0116.0	16,0	Ø 8,0	8,0	M4	M4	500
10035AA0117.0	17,0	Ø 8,0	8,0	M4	M4	500
10035AA0118.0	18,0	Ø 8,0	8,0	M4	M4	500
10035AA0119.0	19,0	Ø 8,0	8,0	M4	M4	500
10035AA0120.0	20,0	Ø 8,0	8,0	M4	M4	500
10035AA0121.0	21,0	Ø 8,0	8,0	M4	M4	500
10035AA0122.0	22,0	Ø 8,0	8,0	M4	M4	500
10035AA0123.0	23,0	Ø 8,0	8,0	M4	M4	500
10035AA0124.0	24,0	Ø 8,0	8,0	M4	M4	500
10035AA0125.0	25,0	Ø 8,0	8,0	M4	M4	500
10035AA0126.0	26,0	Ø 8,0	8,0	M4	M4	500
10035AA0127.0	27,0	Ø 8,0	8,0	M4	M4	500
10035AA0128.0	28,0	Ø 8,0	8,0	M4	M4	500
10035AA0129.0	29,0	Ø 8,0	8,0	M4	M4	500
10035AA0130.0	30,0	Ø 8,0	8,0	M4	M4	500
10035AA0131.0	31,0	Ø 8,0	8,0	M4	M4	500
10035AA0132.0	32,0	Ø 8,0	8,0	M4	M4	500
10035AA0133.0	33,0	Ø 8,0	8,0	M4	M4	500
10035AA0134.0	34,0	Ø 8,0	8,0	M4	M4	500
10035AA0135.0	35,0	Ø 8,0	8,0	M4	M4	500
10035AA0136.0	36,0	Ø 8,0	8,0	M4	M4	500

Codice	A	B	C	D	E	Conf./pezzi
10035AA0137.0	37,0	Ø 8,0	8,0	M4	M4	500
10035AA0138.0	38,0	Ø 8,0	8,0	M4	M4	500
10035AA0139.0	39,0	Ø 8,0	8,0	M4	M4	500
10035AA0140.0	40,0	Ø 8,0	8,0	M4	M4	500
10035AA0141.0	41,0	Ø 8,0	8,0	M4	M4	500
10035AA0142.0	42,0	Ø 8,0	8,0	M4	M4	500
10035AA0143.0	43,0	Ø 8,0	8,0	M4	M4	500
10035AA0144.0	44,0	Ø 8,0	8,0	M4	M4	500
10035AA0145.0	45,0	Ø 8,0	8,0	M4	M4	500
10035AA0146.0	46,0	Ø 8,0	8,0	M4	M4	500
10035AA0147.0	47,0	Ø 8,0	8,0	M4	M4	500
10035AA0148.0	48,0	Ø 8,0	8,0	M4	M4	500
10035AA0149.0	49,0	Ø 8,0	8,0	M4	M4	500
10035AA0150.0	50,0	Ø 8,0	8,0	M4	M4	500
10035AA0151.0	51,0	Ø 8,0	8,0	M4	M4	500
10035AA0152.0	52,0	Ø 8,0	8,0	M4	M4	500
10035AA0153.0	53,0	Ø 8,0	8,0	M4	M4	500
10035AA0154.0	54,0	Ø 8,0	8,0	M4	M4	500
10035AA0155.0	55,0	Ø 8,0	8,0	M4	M4	500
10035AA0156.0	56,0	Ø 8,0	8,0	M4	M4	500
10035AA0157.0	57,0	Ø 8,0	8,0	M4	M4	500
10035AA0158.0	58,0	Ø 8,0	8,0	M4	M4	500
10035AA0159.0	59,0	Ø 8,0	8,0	M4	M4	500
10035AA0160.0	60,0	Ø 8,0	8,0	M4	M4	500
10035AA0161.0	61,0	Ø 8,0	8,0	M4	M4	500