

## DISTANZIATORI M/F M6 ESAGONO 10,0



### Descrizione tecnica

**Materiale:** PA 6.6

**Colore:** nero

**Autoestinguenza:** HB (UL 94)

**Temperatura esercizio:** -30°C ~ +130°C

Tutte le quote sono in mm

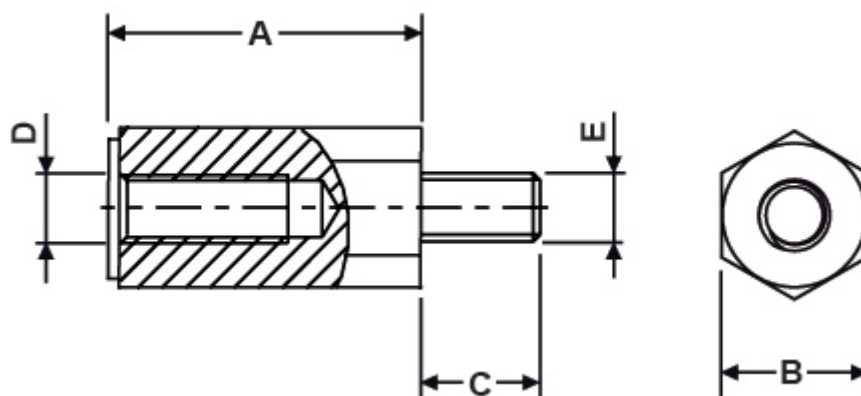

Codice	A	B	C	D	E	Conf./pezzi
10022AA0108.0	8,0	10,0	8,0	M6	M6	500
10022AA0109.0	9,0	10,0	8,0	M6	M6	500
10022AA0110.0	10,0	10,0	8,0	M6	M6	500
10022AA0111.0	11,0	10,0	8,0	M6	M6	500
10022AA0112.0	12,0	10,0	8,0	M6	M6	500
10022AA0113.0	13,0	10,0	8,0	M6	M6	500
10022AA0114.0	14,0	10,0	8,0	M6	M6	500

Codice	A	B	C	D	E	Conf./pezzi
10022AA0115.0	15,0	10,0	8,0	M6	M6	500
10022AA0116.0	16,0	10,0	8,0	M6	M6	500
10022AA0117.0	17,0	10,0	8,0	M6	M6	500
10022AA0118.0	18,0	10,0	8,0	M6	M6	500
10022AA0119.0	19,0	10,0	8,0	M6	M6	500
10022AA0120.0	20,0	10,0	8,0	M6	M6	500
10022AA0121.0	21,0	10,0	8,0	M6	M6	500
10022AA0122.0	22,0	10,0	8,0	M6	M6	500
10022AA0123.0	23,0	10,0	8,0	M6	M6	500
10022AA0124.0	24,0	10,0	8,0	M6	M6	500
10022AA0125.0	25,0	10,0	8,0	M6	M6	500
10022AA0126.0	26,0	10,0	8,0	M6	M6	500
10022AA0127.0	27,0	10,0	8,0	M6	M6	500
10022AA0128.0	28,0	10,0	8,0	M6	M6	500
10022AA0129.0	29,0	10,0	8,0	M6	M6	500
10022AA0130.0	30,0	10,0	8,0	M6	M6	500
10022AA0131.0	31,0	10,0	8,0	M6	M6	500
10022AA0132.0	32,0	10,0	8,0	M6	M6	500
10022AA0133.0	33,0	10,0	8,0	M6	M6	500
10022AA0134.0	34,0	10,0	8,0	M6	M6	500
10022AA0135.0	35,0	10,0	8,0	M6	M6	500
10022AA0136.0	36,0	10,0	8,0	M6	M6	500
10022AA0137.0	37,0	10,0	8,0	M6	M6	500
10022AA0138.0	38,0	10,0	8,0	M6	M6	500
10022AA0139.0	39,0	10,0	8,0	M6	M6	500
10022AA0140.0	40,0	10,0	8,0	M6	M6	500
10022AA0141.0	41,0	10,0	8,0	M6	M6	500
10022AA0142.0	42,0	10,0	8,0	M6	M6	500
10022AA0143.0	43,0	10,0	8,0	M6	M6	500
10022AA0144.0	44,0	10,0	8,0	M6	M6	500
10022AA0145.0	45,0	10,0	8,0	M6	M6	500

Codice	A	B	C	D	E	Conf./pezzi
10022AA0146.0	46,0	10,0	8,0	M6	M6	500
10022AA0147.0	47,0	10,0	8,0	M6	M6	500
10022AA0148.0	48,0	10,0	8,0	M6	M6	500
10022AA0149.0	49,0	10,0	8,0	M6	M6	500
10022AA0150.0	50,0	10,0	8,0	M6	M6	500
10022AA0151.0	51,0	10,0	8,0	M6	M6	500
10022AA0152.0	52,0	10,0	8,0	M6	M6	500
10022AA0153.0	53,0	10,0	8,0	M6	M6	500
10022AA0154.0	54,0	10,0	8,0	M6	M6	500
10022AA0155.0	55,0	10,0	8,0	M6	M6	500
10022AA0156.0	56,0	10,0	8,0	M6	M6	500
10022AA0157.0	57,0	10,0	8,0	M6	M6	500
10022AA0158.0	58,0	10,0	8,0	M6	M6	500
10022AA0159.0	59,0	10,0	8,0	M6	M6	500
10022AA0160.0	60,0	10,0	8,0	M6	M6	500
10022AA0161.0	61,0	10,0	8,0	M6	M6	500
10022AA0162.0	62,0	10,0	8,0	M6	M6	500
10022AA0163.0	63,0	10,0	8,0	M6	M6	500
10022AA0164.0	64,0	10,0	8,0	M6	M6	500
10022AA0165.0	65,0	10,0	8,0	M6	M6	500