

DISTANZIATORI M/F M4 ESAGONO 7,0



Descrizione tecnica

Materiale: PA 6.6

Colore: Nero

Autoestinguenza: HB (UL 94)

Temperatura esercizio: -30°C ~ +150°C

Tutte le quote sono in mm

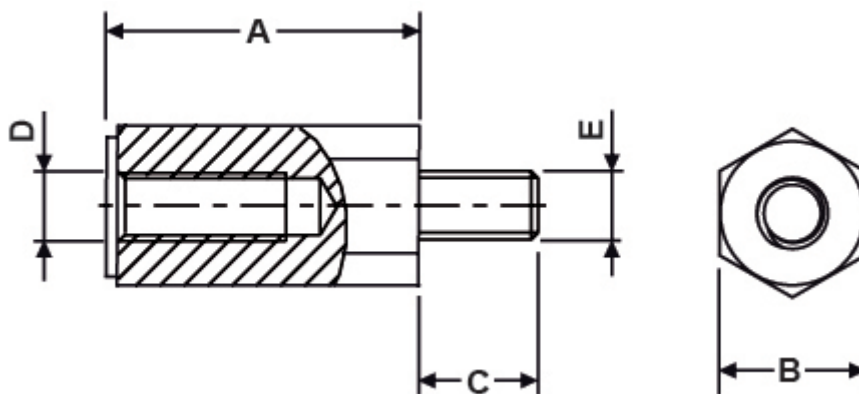

Codice	A	B	C	D	E	Conf./pezzi
10018AA0105.0	5,0	7,0	8,0	M4	M4	500
10018AA0106.0	6,0	7,0	8,0	M4	M4	500
10018AA0107.0	7,0	7,0	8,0	M4	M4	500
10018AA0108.0	8,0	7,0	8,0	M4	M4	500
10018AA0109.0	9,0	7,0	8,0	M4	M4	500
10018AA0110.0	10,0	7,0	8,0	M4	M4	500
10018AA0111.0	11,0	7,0	8,0	M4	M4	500

Codice	A	B	C	D	E	Conf./pezzi
10018AA0112.0	12,0	7,0	8,0	M4	M4	500
10018AA0113.0	13,0	7,0	8,0	M4	M4	500
10018AA0114.0	14,0	7,0	8,0	M4	M4	500
10018AA0115.0	15,0	7,0	8,0	M4	M4	500
10018AA0116.0	16,0	7,0	8,0	M4	M4	500
10018AA0117.0	17,0	7,0	8,0	M4	M4	500
10018AA0118.0	18,0	7,0	8,0	M4	M4	500
10018AA0119.0	19,0	7,0	8,0	M4	M4	500
10018AA0120.0	20,0	7,0	8,0	M4	M4	500
10018AA0121.0	21,0	7,0	8,0	M4	M4	500
10018AA0122.0	22,0	7,0	8,0	M4	M4	500
10018AA0123.0	23,0	7,0	8,0	M4	M4	500
10018AA0124.0	24,0	7,0	8,0	M4	M4	500
10018AA0125.0	25,0	7,0	8,0	M4	M4	500
10018AA0126.0	26,0	7,0	8,0	M4	M4	500
10018AA0127.0	27,0	7,0	8,0	M4	M4	500
10018AA0128.0	28,0	7,0	8,0	M4	M4	500
10018AA0129.0	29,0	7,0	8,0	M4	M4	500
10018AA0130.0	30,0	7,0	8,0	M4	M4	500
10018AA0131.0	31,0	7,0	8,0	M4	M4	500
10018AA0132.0	32,0	7,0	8,0	M4	M4	500
10018AA0133.0	33,0	7,0	8,0	M4	M4	500
10018AA0134.0	34,0	7,0	8,0	M4	M4	500
10018AA0135.0	35,0	7,0	8,0	M4	M4	500
10018AA0136.0	36,0	7,0	8,0	M4	M4	500
10018AA0137.0	37,0	7,0	8,0	M4	M4	500
10018AA0138.0	38,0	7,0	8,0	M4	M4	500
10018AA0139.0	39,0	7,0	8,0	M4	M4	500
10018AA0140.0	40,0	7,0	8,0	M4	M4	500
10018AA0141.0	41,0	7,0	8,0	M4	M4	500
10018AA0142.0	42,0	7,0	8,0	M4	M4	500

Codice	A	B	C	D	E	Conf./pezzi
10018AA0143.0	43,0	7,0	8,0	M4	M4	500
10018AA0144.0	44,0	7,0	8,0	M4	M4	500
10018AA0145.0	45,0	7,0	8,0	M4	M4	500
10018AA0146.0	46,0	7,0	8,0	M4	M4	500
10018AA0147.0	47,0	7,0	8,0	M4	M4	500
10018AA0148.0	48,0	7,0	8,0	M4	M4	500
10018AA0149.0	49,0	7,0	8,0	M4	M4	500
10018AA0150.0	50,0	7,0	8,0	M4	M4	500
10018AA0151.0	51,0	7,0	8,0	M4	M4	500
10018AA0152.0	52,0	7,0	8,0	M4	M4	500
10018AA0153.0	53,0	7,0	8,0	M4	M4	500
10018AA0154.0	54,0	7,0	8,0	M4	M4	500
10018AA0155.0	55,0	7,0	8,0	M4	M4	500
10018AA0156.0	56,0	7,0	8,0	M4	M4	500
10018AA0157.0	57,0	7,0	8,0	M4	M4	500
10018AA0158.0	58,0	7,0	8,0	M4	M4	500
10018AA0159.0	59,0	7,0	8,0	M4	M4	500
10018AA0160.0	60,0	7,0	8,0	M4	M4	500
10018AA0161.0	61,0	7,0	8,0	M4	M4	500