

## SEPARADOR M4 CON CLIP THICKNESS 2.1



### Descripción Técnica

**Material:** PA66

**Color:** Negro

**Autoextinguibilidad:** UL94-HB

**Temperatura de trabajo:** -30°C ~ +150°C

Todas las medidas están indicadas en mm

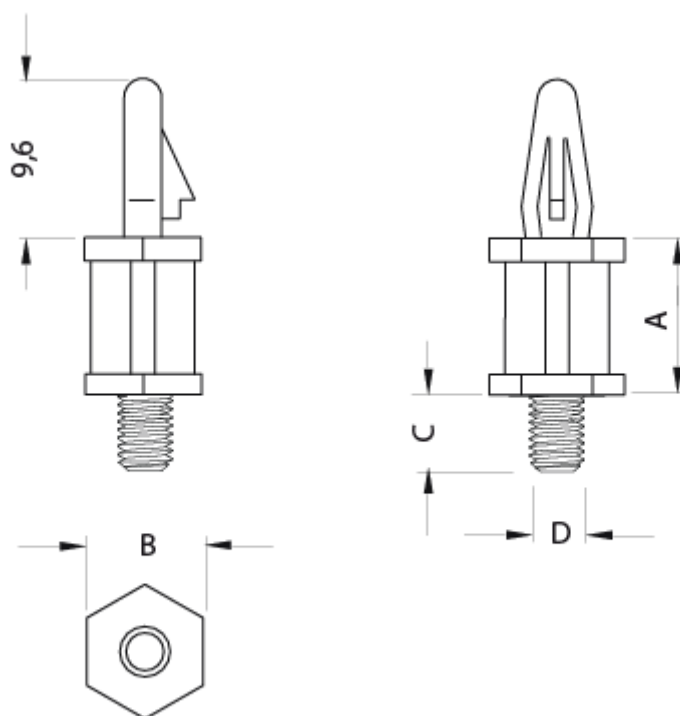

Codigo	A	B	C	D	Orificio	Espesor	Conf./piezas
10058AA0103.0	3,0	6,0	6,5	M4	Ø 4,0	2,1	500
10058AA0104.0	4,0	6,0	6,5	M4	Ø 4,0	2,1	500
10058AA0105.0	5,0	6,0	6,5	M4	Ø 4,0	2,1	500
10058AA0106.0	6,0	6,0	6,5	M4	Ø 4,0	2,1	500
10058AA0107.0	7,0	6,0	6,5	M4	Ø 4,0	2,1	500
10058AA0108.0	8,0	6,0	6,5	M4	Ø 4,0	2,1	500
10058AA0109.0	9,0	6,0	6,5	M4	Ø 4,0	2,1	500
10058AA0110.0	10,0	6,0	6,5	M4	Ø 4,0	2,1	500
10058AA0111.0	11,0	6,0	6,5	M4	Ø 4,0	2,1	500
10058AA0112.0	12,0	6,0	6,5	M4	Ø 4,0	2,1	500
10058AA0113.0	13,0	6,0	6,5	M4	Ø 4,0	2,1	500
10058AA0114.0	14,0	6,0	6,5	M4	Ø 4,0	2,1	500
10058AA0115.0	15,0	6,0	6,5	M4	Ø 4,0	2,1	500
10058AA0116.0	16,0	6,0	6,5	M4	Ø 4,0	2,1	500
10058AA0117.0	17,0	6,0	6,5	M4	Ø 4,0	2,1	500
10058AA0118.0	18,0	6,0	6,5	M4	Ø 4,0	2,1	500
10058AA0119.0	19,0	6,0	6,5	M4	Ø 4,0	2,1	500
10058AA0120.0	20,0	6,0	6,5	M4	Ø 4,0	2,1	500
10058AA0121.0	21,0	6,0	6,5	M4	Ø 4,0	2,1	500
10058AA0122.0	22,0	6,0	6,5	M4	Ø 4,0	2,1	500
10058AA0123.0	23,0	6,0	6,5	M4	Ø 4,0	2,1	500
10058AA0124.0	24,0	6,0	6,5	M4	Ø 4,0	2,1	500
10058AA0125.0	25,0	6,0	6,5	M4	Ø 4,0	2,1	500
10058AA0126.0	26,0	6,0	6,5	M4	Ø 4,0	2,1	500
10058AA0127.0	27,0	6,0	6,5	M4	Ø 4,0	2,1	500
10058AA0128.0	28,0	6,0	6,5	M4	Ø 4,0	2,1	500
10058AA0129.0	29,0	6,0	6,5	M4	Ø 4,0	2,1	500
10058AA0130.0	30,0	6,0	6,5	M4	Ø 4,0	2,1	500
10058AA0131.0	31,0	6,0	6,5	M4	Ø 4,0	2,1	500
10058AA0132.0	32,0	6,0	6,5	M4	Ø 4,0	2,1	500
10058AA0133.0	33,0	6,0	6,5	M4	Ø 4,0	2,1	500

Codigo	A	B	C	D	Orificio	Espesor	Conf./piezas
10058AA0134.0	34,0	6,0	6,5	M4	Ø 4,0	2,1	500
10058AA0135.0	35,0	6,0	6,5	M4	Ø 4,0	2,1	500
10058AA0136.0	36,0	6,0	6,5	M4	Ø 4,0	2,1	500
10058AA0137.0	37,0	6,0	6,5	M4	Ø 4,0	2,1	500
10058AA0138.0	38,0	6,0	6,5	M4	Ø 4,0	2,1	500
10058AA0139.0	39,0	6,0	6,5	M4	Ø 4,0	2,1	500
10058AA0140.0	40,0	6,0	6,5	M4	Ø 4,0	2,1	500
10058AA0141.0	41,0	6,0	6,5	M4	Ø 4,0	2,1	500
10058AA0142.0	42,0	6,0	6,5	M4	Ø 4,0	2,1	500
10058AA0143.0	43,0	6,0	6,5	M4	Ø 4,0	2,1	500
10058AA0144.0	44,0	6,0	6,5	M4	Ø 4,0	2,1	500
10058AA0145.0	45,0	6,0	6,5	M4	Ø 4,0	2,1	500
10058AA0146.0	46,0	6,0	6,5	M4	Ø 4,0	2,1	500
10058AA0147.0	47,0	6,0	6,5	M4	Ø 4,0	2,1	500
10058AA0148.0	48,0	6,0	6,5	M4	Ø 4,0	2,1	500
10058AA0149.0	49,0	6,0	6,5	M4	Ø 4,0	2,1	500
10058AA0150.0	50,0	6,0	6,5	M4	Ø 4,0	2,1	500
10058AA0151.0	51,0	6,0	6,5	M4	Ø 4,0	2,1	500
10058AA0152.0	52,0	6,0	6,5	M4	Ø 4,0	2,1	500
10058AA0153.0	53,0	6,0	6,5	M4	Ø 4,0	2,1	500
10058AA0154.0	54,0	6,0	6,5	M4	Ø 4,0	2,1	500
10058AA0155.0	55,0	6,0	6,5	M4	Ø 4,0	2,1	500
10058AA0156.0	56,0	6,0	6,5	M4	Ø 4,0	2,1	500
10058AA0157.0	57,0	6,0	6,5	M4	Ø 4,0	2,1	500
10058AA0158.0	58,0	6,0	6,5	M4	Ø 4,0	2,1	500
10058AA0159.0	59,0	6,0	6,5	M4	Ø 4,0	2,1	500
10058AA0160.0	60,0	6,0	6,5	M4	Ø 4,0	2,1	500
10058AA0161.0	61,0	6,0	6,5	M4	Ø 4,0	2,1	500
10058AA0162.0	62,0	6,0	6,5	M4	Ø 4,0	2,1	500
10058AA0163.0	63,0	6,0	6,5	M4	Ø 4,0	2,1	500
10058AA0164.0	64,0	6,0	6,5	M4	Ø 4,0	2,1	500

Codigo	A	B	C	D	Orificio	Espesor	Conf./piezas
10058AA0165.0	65,0	6,0	6,5	M4	Ø 4,0	2,1	500