

METRIC M4 SPACERS WITH SNAP-LOCK HOLE Ø 4,0



Technical description

Material: PA 6.6

Colour: Black

UL Flammability: HB (UL 94)

Operating temperature: -30°C ~ +150°C

All dimensions are in mm.

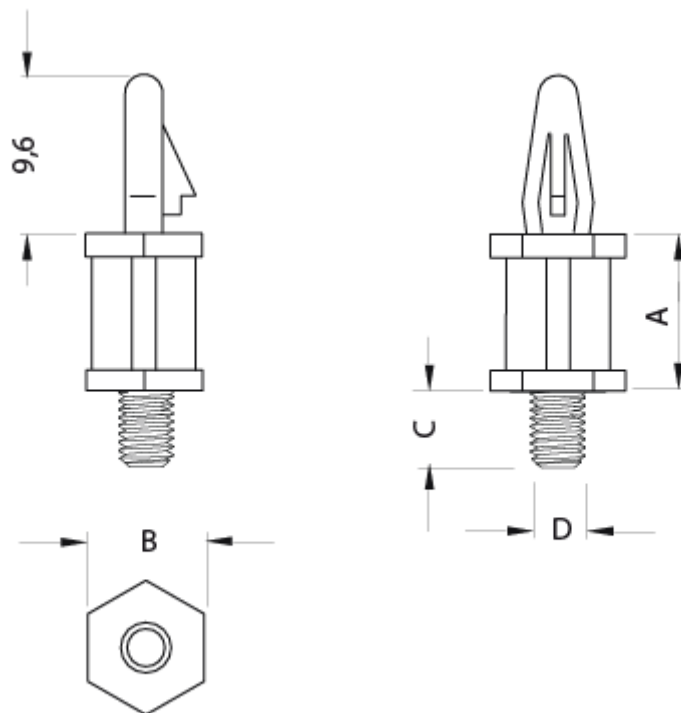

Code	A	B	C	D	Mounting hole	Thickness	MOQ-Pcs
10063AA0103.0	3,0	8,0	6,5	M4	Ø 4,0	2,4	500

Code	A	B	C	D	Mounting hole	Thickness	MOQ-Pcs
10063AA0104.0	4,0	8,0	6,5	M4	Ø 4,0	2,4	500
10063AA0105.0	5,0	8,0	6,5	M4	Ø 4,0	2,4	500
10063AA0106.0	6,0	8,0	6,5	M4	Ø 4,0	2,4	500
10063AA0107.0	7,0	8,0	6,5	M4	Ø 4,0	2,4	500
10063AA0108.0	8,0	8,0	6,5	M4	Ø 4,0	2,4	500
10063AA0109.0	9,0	8,0	6,5	M4	Ø 4,0	2,4	500
10063AA0110.0	10,0	8,0	6,5	M4	Ø 4,0	2,4	500
10063AA0111.0	11,0	8,0	6,5	M4	Ø 4,0	2,4	500
10063AA0112.0	12,0	8,0	6,5	M4	Ø 4,0	2,4	500
10063AA0113.0	13,0	8,0	6,5	M4	Ø 4,0	2,4	500
10063AA0114.0	14,0	8,0	6,5	M4	Ø 4,0	2,4	500
10063AA0115.0	15,0	8,0	6,5	M4	Ø 4,0	2,4	500
10063AA0116.0	16,0	8,0	6,5	M4	Ø 4,0	2,4	500
10063AA0117.0	17,0	8,0	6,5	M4	Ø 4,0	2,4	500
10063AA0118.0	18,0	8,0	6,5	M4	Ø 4,0	2,4	500
10063AA0119.0	19,0	8,0	6,5	M4	Ø 4,0	2,4	500
10063AA0120.0	20,0	8,0	6,5	M4	Ø 4,0	2,4	500
10063AA0121.0	21,0	8,0	6,5	M4	Ø 4,0	2,4	500
10063AA0122.0	22,0	8,0	6,5	M4	Ø 4,0	2,4	500
10063AA0123.0	23,0	8,0	6,5	M4	Ø 4,0	2,4	500
10063AA0124.0	24,0	8,0	6,5	M4	Ø 4,0	2,4	500
10063AA0125.0	25,0	8,0	6,5	M4	Ø 4,0	2,4	500
10063AA0126.0	26,0	8,0	6,5	M4	Ø 4,0	2,4	500
10063AA0127.0	27,0	8,0	6,5	M4	Ø 4,0	2,4	500
10063AA0128.0	28,0	8,0	6,5	M4	Ø 4,0	2,4	500
10063AA0129.0	29,0	8,0	6,5	M4	Ø 4,0	2,4	500
10063AA0130.0	30,0	8,0	6,5	M4	Ø 4,0	2,4	500
10063AA0131.0	31,0	8,0	6,5	M4	Ø 4,0	2,4	500
10063AA0132.0	32,0	8,0	6,5	M4	Ø 4,0	2,4	500
10063AA0133.0	33,0	8,0	6,5	M4	Ø 4,0	2,4	500
10063AA0134.0	34,0	8,0	6,5	M4	Ø 4,0	2,4	500

Code	A	B	C	D	Mounting hole	Thickness	MOQ-Pcs
10063AA0135.0	35,0	8,0	6,5	M4	Ø 4,0	2,4	500
10063AA0136.0	36,0	8,0	6,5	M4	Ø 4,0	2,4	500
10063AA0137.0	37,0	8,0	6,5	M4	Ø 4,0	2,4	500
10063AA0138.0	38,0	8,0	6,5	M4	Ø 4,0	2,4	500
10063AA0139.0	39,0	8,0	6,5	M4	Ø 4,0	2,4	500
10063AA0140.0	40,0	8,0	6,5	M4	Ø 4,0	2,4	500
10063AA0141.0	41,0	8,0	6,5	M4	Ø 4,0	2,4	500
10063AA0142.0	42,0	8,0	6,5	M4	Ø 4,0	2,4	500
10063AA0143.0	43,0	8,0	6,5	M4	Ø 4,0	2,4	500
10063AA0144.0	44,0	8,0	6,5	M4	Ø 4,0	2,4	500
10063AA0145.0	45,0	8,0	6,5	M4	Ø 4,0	2,4	500
10063AA0146.0	46,0	8,0	6,5	M4	Ø 4,0	2,4	500
10063AA0147.0	47,0	8,0	6,5	M4	Ø 4,0	2,4	500
10063AA0148.0	48,0	8,0	6,5	M4	Ø 4,0	2,4	500
10063AA0149.0	49,0	8,0	6,5	M4	Ø 4,0	2,4	500
10063AA0150.0	50,0	8,0	6,5	M4	Ø 4,0	2,4	500
10063AA0151.0	51,0	8,0	6,5	M4	Ø 4,0	2,4	500
10063AA0152.0	52,0	8,0	6,5	M4	Ø 4,0	2,4	500
10063AA0153.0	53,0	8,0	6,5	M4	Ø 4,0	2,4	500
10063AA0154.0	54,0	8,0	6,5	M4	Ø 4,0	2,4	500
10063AA0155.0	55,0	8,0	6,5	M4	Ø 4,0	2,4	500
10063AA0156.0	56,0	8,0	6,5	M4	Ø 4,0	2,4	500
10063AA0157.0	57,0	8,0	6,5	M4	Ø 4,0	2,4	500
10063AA0158.0	58,0	8,0	6,5	M4	Ø 4,0	2,4	500
10063AA0159.0	59,0	8,0	6,5	M4	Ø 4,0	2,4	500
10063AA0160.0	60,0	8,0	6,5	M4	Ø 4,0	2,4	500
10063AA0161.0	61,0	8,0	6,5	M4	Ø 4,0	2,4	500
10063AA0162.0	62,0	8,0	6,5	M4	Ø 4,0	2,4	500
10063AA0163.0	63,0	8,0	6,5	M4	Ø 4,0	2,4	500
10063AA0164.0	64,0	8,0	6,5	M4	Ø 4,0	2,4	500
10063AA0165.0	65,0	8,0	6,5	M4	Ø 4,0	2,4	500